

Prisms - The two bases name the prism and all other sides are parallelograms

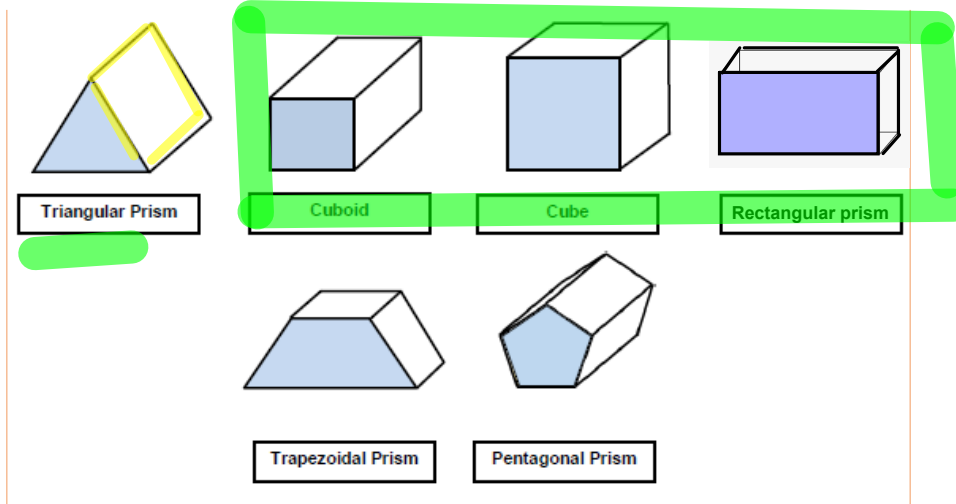

Rectangular Prisms

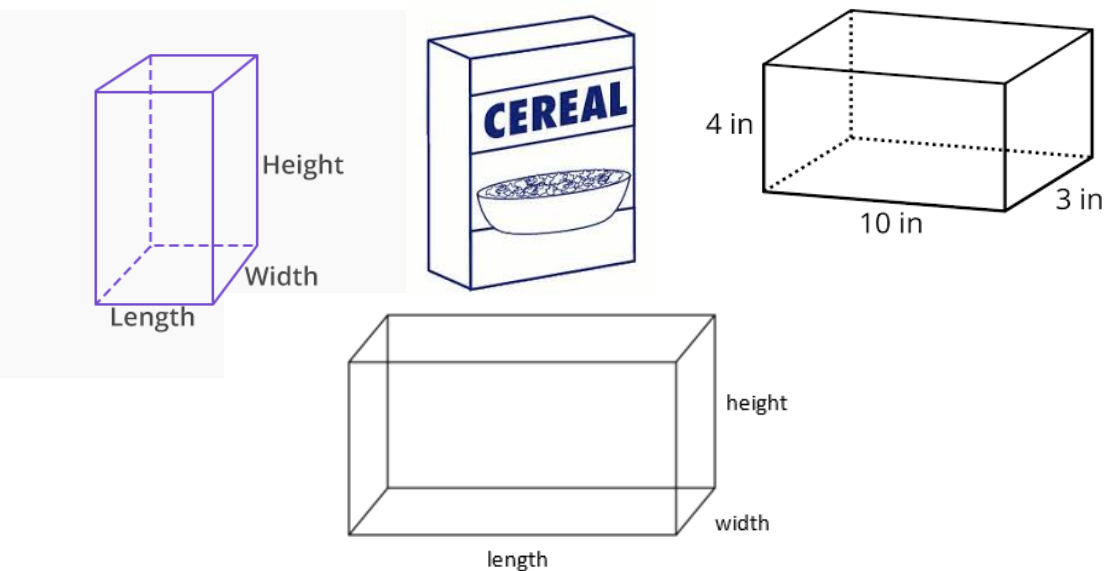

Triangular Prisms

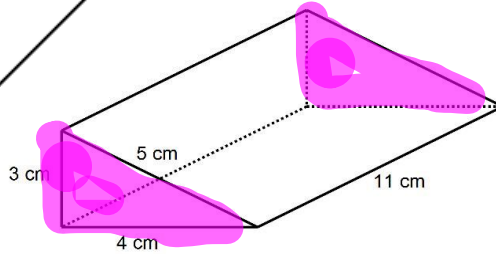
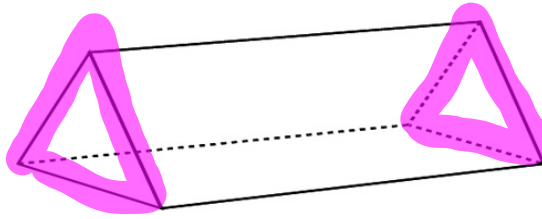
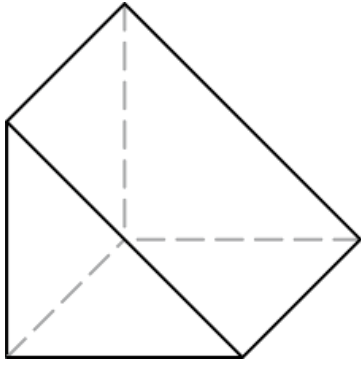

Pyramids - The base names the type of pyramid and all other faces are **triangles** that meet at a point called the apex.



Triangular Pyramid

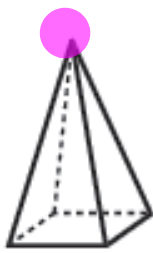

Square Pyramid

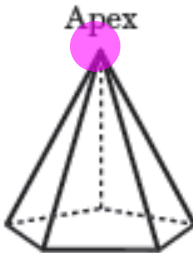

Pentagonal Pyramid

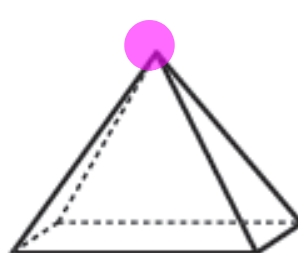

Rectangular Pyramid

Triangular Pyramids

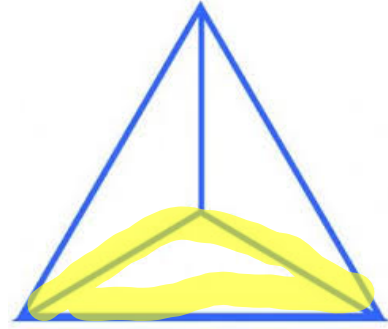
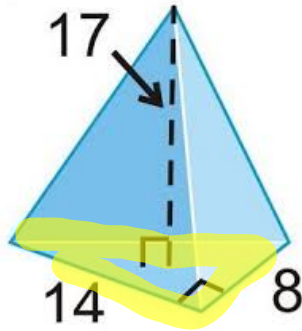
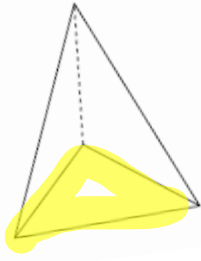

Rectangular and Square Pyramids

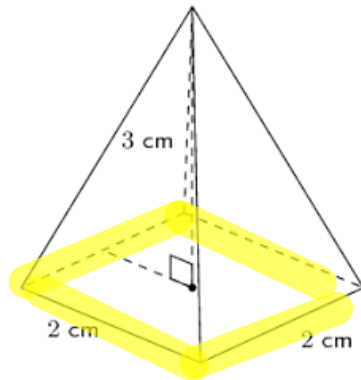
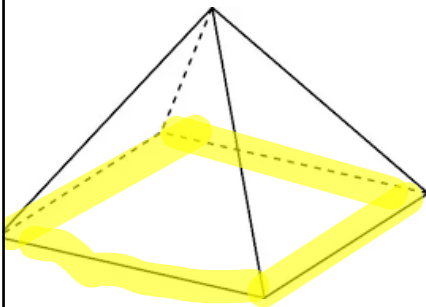

Rectangular Pyramid

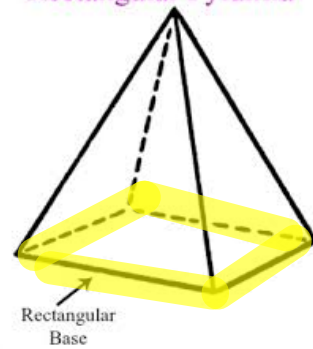

Pyramid vs. Prism

